

## DESCRIPTION

The AT-303AP is a flush-mounted wall attenuator and uses a transformer which allows connection of a wide range of loads (30 W or less). Volume can be adjusted in five steps. The AT-303AP features push-in terminal block for easy connection.

## SPECIFICATIONS

Input Range	0.5 W - 30 W
Attenuation	5 steps (0 dB, -6 dB, -12 dB, -18 dB, OFF)
Applicable Cable	600 V vinyl-insulated cable (Indoor Vinyl or Heat-resistant Indoor Vinyl cable) Solid cable: $\phi 0.8$ (0.03") - $\phi 1.6$ (0.06") mm
Terminal	Push-in connector
Operating Temperature	-10 °C to +50 °C
Finish	Knob, panel, plate: ABS resin, white (RAL 1013 equivalent) Case: ABS resin, black
Dimensions	70 (W) × 120 (H) × 52.4 (D) mm (2.76" × 4.72" × 2.06") (with plate) 41 (W) × 108 (H) × 52.4 (D) mm (1.61" × 4.25" × 2.06") (attenuator only)
Weight	210 g (0.46 lb) (unit only)
Accessory	Plate $\times 1$ , Plate mounting screw $\times 2$ , Box mounting screw $\times 2$
Applicable Plate	YP-1AF (option)
Applicable Box	YS-11A (option)

## APPEARANCE

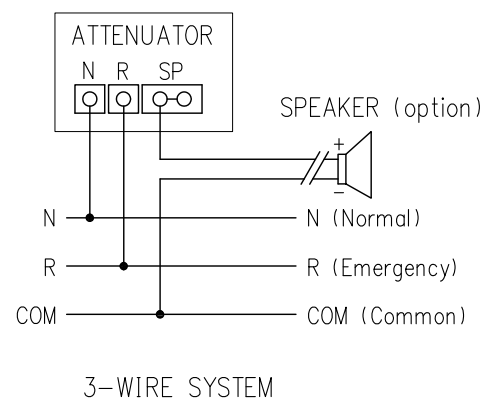
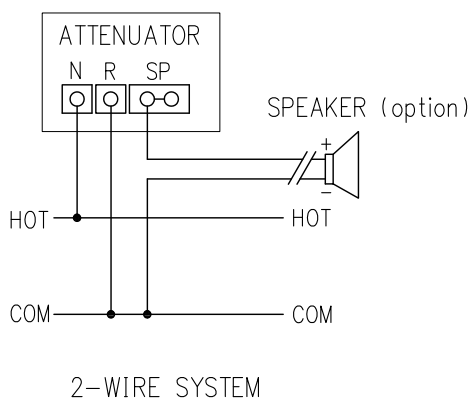
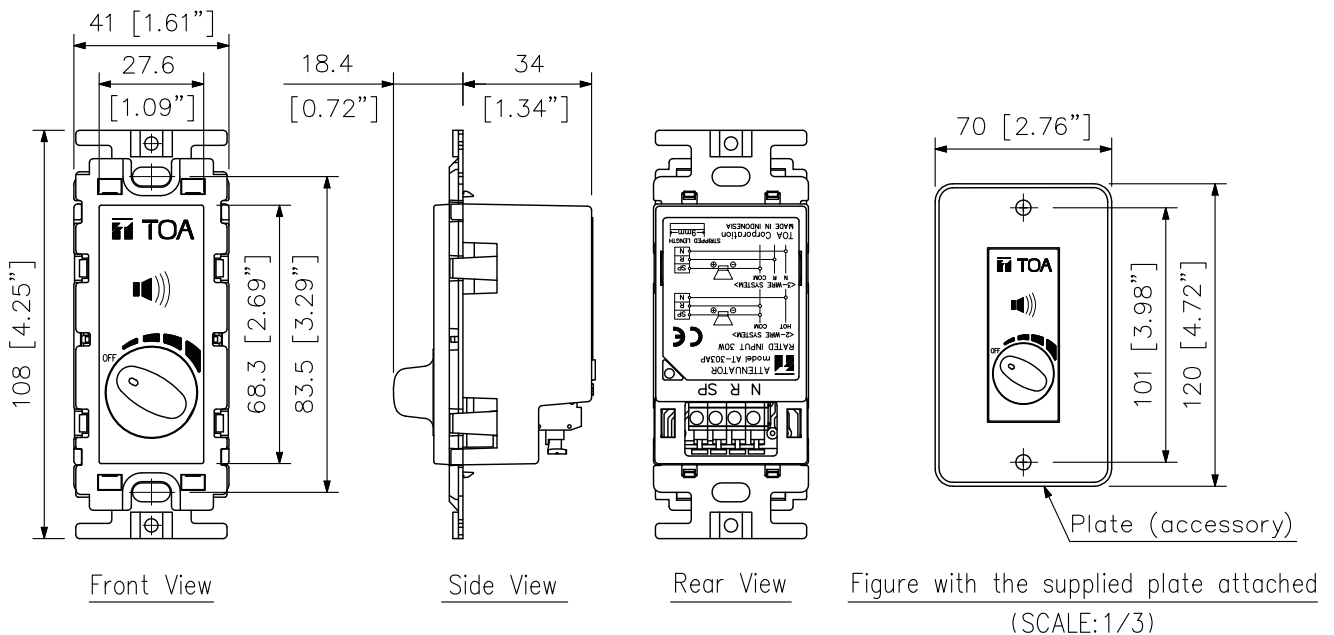

UNIT: mm SCALE: 1/2